

# RT-Q40LCM-C00

## 40Gb/s QSFP+ LR4 Optical Transceiver

### Product Features

- Compliant with 40G Ethernet IEEE802.3ba and 40GBASE-LR4 Standard
- QSFP+ MSA compliant
- Compliant with QDR/DDR Infiniband data rates
- Up to 11.2Gb/s data rate per wavelength
- 4 CWDM lanes MUX/DEMUX design
- Up to 10km transmission on single mode fiber (SMF)
- Operating case temperature: 0 to 70°C
- Maximum power consumption 2.5W
- LC duplex connector
- RoHS compliant

### Applications

- 40GBASE-LR4 Ethernet Links
- InfinibandQDRandDDR interconnects
- Client-side 40G Telecom connections

This product is a transceiver module designed for 2m-10km optical communication applications. The design is compliant to 40GBASE-LR4 of the IEEE P802.3ba standard. The module converts 4 inputs channels (ch) of 10Gb/s electrical data to 4 CWDM optical signals, and multiplexes them into a single channel for 40Gb/s optical transmission. Reversely, on the receiver side, the module optically de-multiplexes a 40Gb/s input into 4 CWDM channels signals, and converts them to 4 channel output electrical data.

The central wavelengths of the 4 CWDM channels are 1271, 1291, 1311 and 1331 nm as members of the CWDM wavelength grid defined in ITU-T G.694.2. It contains a duplex LC connector for the optical interface and a 38-pin connector for the electrical interface. To minimize the optical dispersion in the long-haul system, single-mode fiber (SMF) has to be applied in this module.

The product is designed with form factor, optical/electrical connection and digital diagnostic interface according to the QSFP+ Multi-Source Agreement (MSA). It has been designed to meet the harshest external operating conditions including temperature, humidity and EMI interference.

### Ordering Information

| Part Number   | Description   |
|---------------|---|
| RT-Q40LCM-C00 | QSFP+ LR4 10km optical transceiver with full real-time digital diagnostic monitoring and pull tab |

### For More Information:

Wuhan RayOptekCo.,Ltd  
 Address: G3-201,NewEnergy Building,No.999 Gao Xin Road, Wuhan, Hubei, China  
 Phone:0086-27-87106345 Fax: 0086-27-87106345 Email: sales@rayoptek.com

### Regulatory Compliance

| Feature                              | Standard   | Performance                           |
|--------------------------------------|--|---------------------------------------|
| Electromagnetic Interference (EMI)   | FCC Part 15 Class B<br>EN 55022:2010, Class B                | Compatible with standards             |
| Electromagnetic susceptibility (EMS) | EN 55024:2010  | Compatible with standards             |
| Laser Eye Safety                     | FDA 21CFR 1040.10 and 1040.11<br>EN60950, EN (IEC) 60825-1,2 | Compatible with Class I laser product |

## Functional Description

This product converts the 4-channel 10Gb/s electrical input data into CWDM optical signals (light), by a driven 4-wavelength Distributed Feedback Laser (DFB) array. The light is combined by the MUX parts as a 40Gb/s data, propagating out of the transmitter module from the SMF. The receiver module accepts the 40Gb/s CWDM optical signals input, and de-multiplexes it into 4 individual

10Gb/s channels with different wavelength. Each wavelength light is collected by a discrete photo diode, and then outputted as electric data after amplified first by a TIA and a post amplifier. Figure 1 shows the functional block diagram of this product.

A single +3.3V power supply is required to power up this product. Both power supply pins VccTx and VccRx are internally connected

and should be applied concurrently. As per MSA specifications the module offers 7 low speed hardware control pins (including the 2-wire serial interface): ModSelL, SCL, SDA, ResetL, LPMODE, ModPrsL and IntL.

Module Select (ModSelL) is an input pin. When held low by the host, this product responds to 2-wire serial communication commands. The ModSelL allows the use of this product on a single 2-wire interface bus – individual ModSelL lines must be used.

Serial Clock (SCL) and Serial Data (SDA) are required for the 2-wire serial bus communication interface and enable the host to access

the QSFP+ memory map.

The ResetL pin enables a complete reset, returning the settings to their default state, when a low level on the ResetL pin is held for longer than the minimum pulse length. During the execution of a reset the host shall disregard all status bits until it indicates a completion of the reset interrupt. The product indicates this by posting an IntL (Interrupt) signal with the Data\_Not\_Ready bit negated in the memory map. Note that on power up (including hot insertion) the module should post this completion of reset interrupt without requiring a reset.

Low Power Mode (LPMODE) pin is used to set the maximum power consumption for the product in order to protect hosts that are not capable of cooling higher power modules, should such modules be accidentally inserted.

Module Present (ModPrsL) is a signal local to the host board which, in the absence of a product, is normally pulled up to the host Vcc. When the product is inserted into the connector, it completes the path to ground through a resistor on the host board and asserts the signal. ModPrsL then indicates its present by setting ModPrsL to a “Low” state.

Interrupt (IntL) is an output pin. “Low” indicates a possible operational fault or a status critical to the host system. The host identifies the source of the interrupt using the 2-wire serial interface. The IntL pin is an open collector output and must be pulled to the HostVcc voltage on the Host board.

## Absolute Maximum Ratings

It has to be noted that the operation in excess of any individual absolute maximum ratings might cause permanent damage to this module.

| Parameter                            | Symbol          | Min  | Max | Unit | Notes |
|--------------------------------------|-----------------|------|-----|------|-------|
| Storage Temperature                  | T <sub>S</sub>  | -40  | 85  | °C   |       |
| Operating Case Temperature           | T <sub>OP</sub> | 0    | 70  | °C   |       |
| Power Supply Voltage                 | V <sub>CC</sub> | -0.5 | 3.6 | V    |       |
| Relative Humidity (non-condensation) | RH              | 0    | 85  | %    |       |
| Damage Threshold, each Lane          | TH <sub>d</sub> | 3.3  |     | dBm  |       |

## Recommended Operating Conditions and Power Supply Requirements

| Parameter                  | Symbol          | Min   | Typical | Max             | Unit | Notes |
|----------------------------|-----------------|-------|---------|-----------------|------|-------|
| Operating Case Temperature | T <sub>OP</sub> | 0     |         | 70              | °C   |       |
| Power Supply Voltage       | V <sub>CC</sub> | 3.135 | 3.3     | 3.465           | V    |       |
| Data Rate, each Lane       |                 |       | 10.3125 |                 | Gb/s |       |
| Control Input Voltage High |                 | 2     |         | V <sub>CC</sub> | V    |       |
| Control Input Voltage Low  |                 | 0     |         | 0.8             | V    |       |
| Link Distance with G.652   | D               | 0.002 |         | 10              | km   |       |

## Electrical Characteristics

The following electrical characteristics are defined over the Recommended Operating Environment unless otherwise specified.

| Parameter   | Test Point         | Min                       | Typical | Max  | Unit     | Notes                          |
|---|--------------------|---------------------------|---------|------|----------|--------------------------------|
| Power Consumption                                       |                    |                           |         | 2.5  | W        |                                |
| Supply Current  | I <sub>CC</sub>    |                           |         | 0.7  | A        |                                |
| Transceiver Power-on Initialization Time                |                    |                           |         | 2000 | ms       | 1                              |
| <b>Transmitter (each Lane)</b>                          |                    |                           |         |      |          |                                |
| Single-ended Input Voltage Tolerance (Note 2)           |                    | -0.3                      |         | 4.0  | V        | Referred to TP1 signal common  |
| AC Common Mode Input Voltage Tolerance                  |                    | 15                        |         |      | mV       | RMS                            |
| Differential Input Voltage Swing Threshold              |                    | 50                        |         |      | mVpp     | LOSA Threshold                 |
| Differential Input Voltage Swing                        | V <sub>in,pp</sub> | 190                       |         | 700  | mVpp     |                                |
| Differential Input Impedance                            | Z <sub>in</sub>    | 90                        | 100     | 110  | ohm      |                                |
| Differential Input Return Loss                          |                    | See IEEE 802.3ba 86A.4.11 |         |      | dB       | 10MHz- 11.1GHz                 |
| J2 Jitter Tolerance                                     | Jt2                | 0.17                      |         |      | UI       |                                |
| J9 Jitter Tolerance                                     | Jt9                | 0.29                      |         |      | UI       |                                |
| Data Dependent Pulse Width Shrinkage (DDPWS ) Tolerance |                    | 0.07                      |         |      | UI       |                                |
| Eye Mask Coordinates {X1, X2, Y1, Y2}                   |                    | 0.11, 0.31<br>95, 350     |         |      | UI<br>mV | Hit Ratio = 5x10 <sup>-5</sup> |

| Receiver (each Lane)                  |         |                            |     |      |          |                           |
|---------------------------------------|---------|----------------------------|-----|------|----------|---------------------------|
| Single-ended Output Voltage           |         | -0.3                       |     | 4.0  | V        | Referred to signal common |
| AC Common Mode Output Voltage         |         |                            |     | 7.5  | mV       | RMS                       |
| Differential Output Voltage Swing     | Vout,pp | 300                        |     | 850  | mVpp     |                           |
| Differential Output Impedance         | Zout    | 90                         | 100 | 110  | ohm      |                           |
| Termination Mismatch at 1MHz          |         |                            |     | 5    | %        |                           |
| Differential Output Return Loss       |         | See IEEE 802.3ba 86A.4.2.1 |     |      | dB       | 10MHz- 11.1GHz            |
| Common Mode Output Return Loss        |         | See IEEE 802.3ba 86A.4.2.2 |     |      | dB       | 10MHz- 11.1GHz            |
| Output Transition Time                |         | 28                         |     |      | Ps       | 20% to 80%                |
| J2 Jitter Output                      | Jo2     |                            |     | 0.42 | UI       |                           |
| J9 Jitter Output                      | Jo9     |                            |     | 0.65 | UI       |                           |
| Eye Mask Coordinates {X1, X2, Y1, Y2} |         | 0.29, 0.5, 150, 425        |     |      | UI<br>mV | Hit Ratio = 5x10-5        |

Notes:

- 1.Power-on Initialization Time is the time from when the power supply voltages reach and remain above the minimum recommended operating supply voltages to the time when the module is fully functional.
2. The single ended input voltage tolerance is the allowable range of the instantaneous input signals.

### Optical Characteristics

| Parameter             | Symbol | Min    | Typical | Max    | Unit | Notes |
|-----------------------|--------|--------|---------|--------|------|-------|
| Wavelength Assignment | L0     | 1264.5 | 1271    | 1277.5 | nm   |       |
|                       | L1     | 1284.5 | 1291    | 1297.5 | nm   |       |
|                       | L2     | 1304.5 | 1311    | 1317.5 | nm   |       |
|                       | L3     | 1324.5 | 1331    | 1337.5 | nm   |       |

| Transmitter   |                      |                                    |  |      |       |                 |
|---|----------------------|------------------------------------|--|------|-------|-----------------|
| Side Mode Suppression Ratio   | SMSR                 | 30                                 |  |      | dB    |                 |
| Total Average Launch Power  | P <sub>T</sub>       |                                    |  | 8.3  | dBm   |                 |
| Average Launch Power, each Lane   | P <sub>AVG</sub>     | -7                                 |  | 2.3  | dBm   |                 |
| Optical Modulation Amplitude (OMA), each Lane                                 | P <sub>OMA</sub>     | -4                                 |  | 3.5  | dBm   | 1               |
| Difference in Launch Power between any Two Lanes (OMA)                        | P <sub>tx,diff</sub> |                                    |  | 6.5  | dB    |                 |
| Launch Power in OMA minus Transmitter and Dispersion Penalty (TDP), each Lane |                      | -4.8                               |  |      | dBm   |                 |
| TDP, each Lane  | TDP                  |                                    |  | 2.6  | dB    |                 |
| Extinction Ratio  | ER                   | 3.5                                |  |      | dB    |                 |
| Relative Intensity Noise  | RIN                  |                                    |  | -128 | dB/Hz | 12dB reflection |
| OpticalReturnLossTolerance  | TOL                  |                                    |  | 20   | dB    |                 |
| TransmitterReflectance  | R <sub>T</sub>       |                                    |  | -12  | dB    |                 |
| Transmitter Eye Mask Definition {X1, X2, X3, Y1, Y2, Y3}                      |                      | {0.25, 0.4, 0.45, 0.25, 0.28, 0.4} |  |      |       |                 |
| Average Launch Power OFF Transmitter, each Lane                               | Poff                 |                                    |  | -30  | dBm   |                 |

### Receiver

|  |                 |       |      |       |     |   |
|--|-----------------|-------|------|-------|-----|---|
| Damage Threshold, each Lane                                    | TH <sub>d</sub> | 3.3   |      |       | dBm | 2 |
| Total Average Receive Power                                    |                 |       |      | 8.3   | dBm |   |
| Average Receive Power, each Lane                               |                 | -13.7 |      | 2.3   | dBm |   |
| Receiver Reflectance   | R <sub>R</sub>  |       |      | -26   | dB  |   |
| Receiver Sensitivity (OMA), each Lane                          | SEN             |       |      | -11.5 | dBm |   |
| Stressed Receiver Sensitivity (OMA), each Lane                 |                 |       |      | -9.6  | dBm | 3 |
| Difference in Receive Power between any Two Lanes (OMA)        | Prx,diff        |       |      | 7.5   | dB  |   |
| LOS Assert   | LOSA            | -28   |      |       | dBm |   |
| LOS Deassert   | LOSD            |       |      | -15   | dBm |   |
| LOS Hysteresis   | LOSH            | 0.5   |      |       | dB  |   |
| Receiver Electrical 3 dB upper Cutoff Frequency, each Lane     | F <sub>c</sub>  |       |      | 12.3  | GHz |   |
| <b>Conditions of Stress Receiver Sensitivity Test (Note 5)</b> |                 |       |      |       |     |   |
| Vertical Eye Closure Penalty, each Lane                        |                 |       | 1.9  |       | dB  |   |
| Stressed Eye J2 Jitter, each Lane                              |                 |       | 0.3  |       | UI  |   |
| Stressed Eye J9 Jitter, each Lane                              |                 |       | 0.47 |       | UI  |   |

Notes:

1. Even if the TDP < 0.8 dB, the OMA min must exceed the minimum value specified here.
2. The receiver shall be able to tolerate, without damage, continuous exposure to a modulated optical input signal having this power level on one lane. The receiver does not have to operate correctly at this input power.
3. Measured with conformance test signal at receiver input for BER = 1x10<sup>-12</sup>.
4. MVertical eye closure penalty and stressed eye jitter are test conditions for measuring stressed receiver sensitivity. They are not characteristics of the receiver.

## Digital Diagnostic Functions

The following digital diagnostic characteristics are defined over the normal operating conditions unless otherwise specified.

| Parameter                               | Symbol       | Min  | Max  | Unit | Notes                            |
|---|--------------|------|------|------|----------------------------------|
| Temperature monitor absolute error      | DMI_Temp     | -3   | +3   | °C   | Over operating temperature range |
| Supply voltage monitor absolute error   | DMI_VCC      | -0.1 | +0.1 | V    | Over full operating range        |
| Channel RX power monitor absolute error | DMI_RX_Ch    | -2   | +2   | dB   | 1                                |
| Channel Bias current monitor            | DMI_Ibias_Ch | -10% | +10% | mA   |                                  |
| Channel TX power monitor absolute error | DMI_TX_Ch    | -2   | +2   | dB   | 1                                |

Notes:

1. Due to measurement accuracy of different single mode fibers, there could be an additional +/- 1 dB fluctuation, or a +/- 3 dB total accuracy.

## Block Diagram of Transceiver

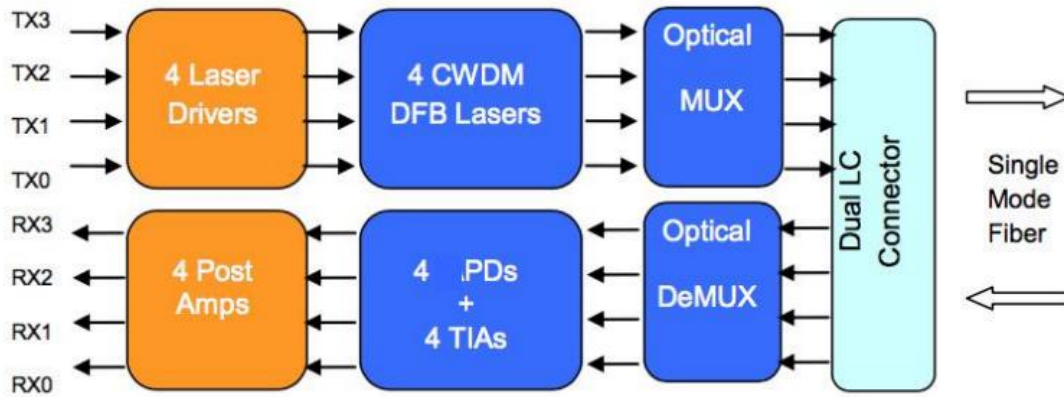

## Recommended Power Supply Filter

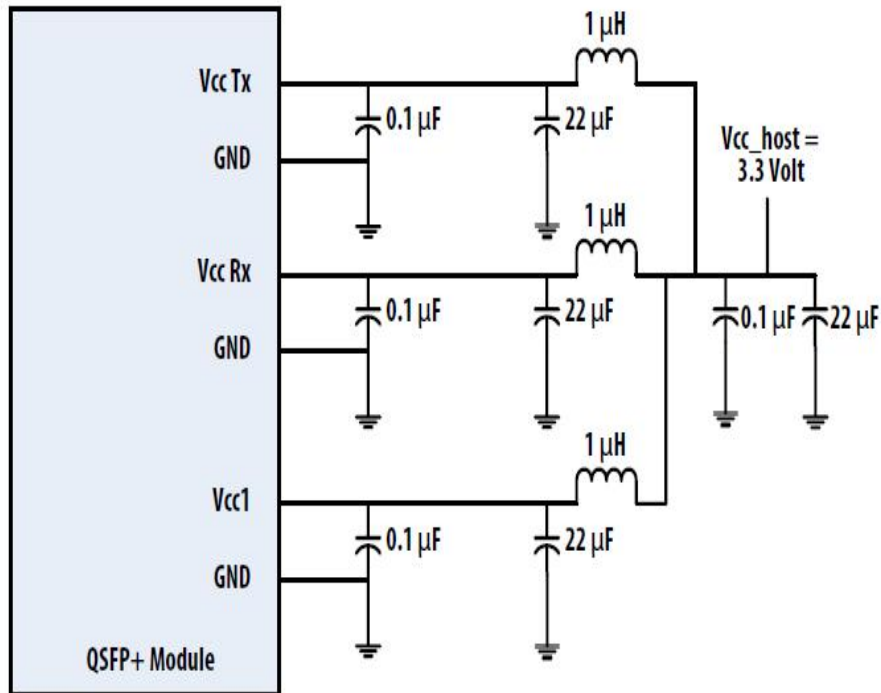

## Mechanical Dimensions

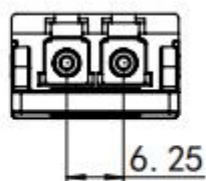
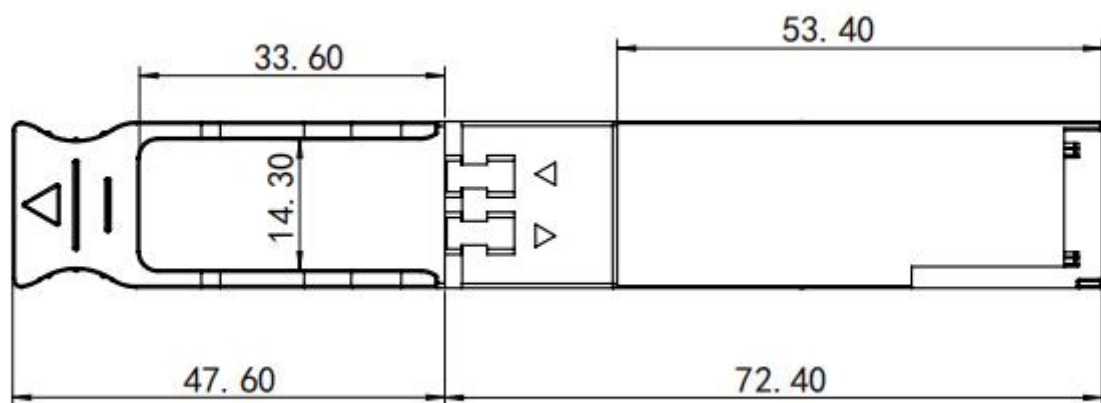
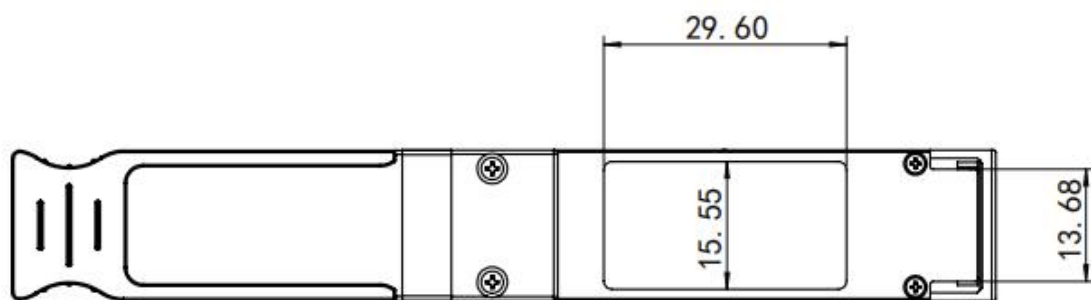
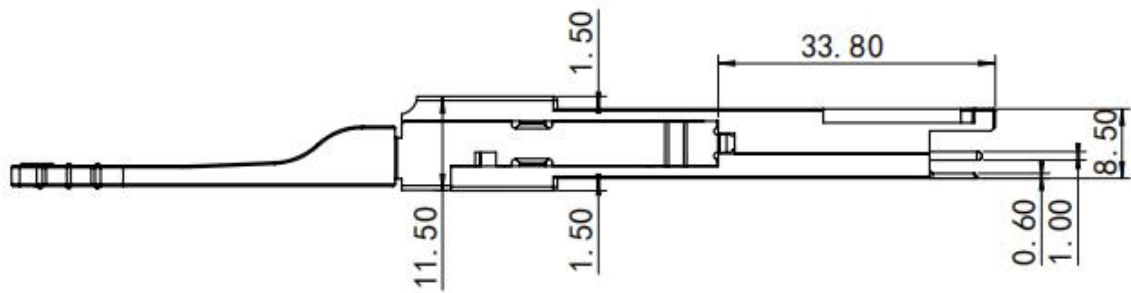

## ESD

This transceiver is specified as ESD threshold 1kV for SFI pins and 2kV for all other electrical input pins, tested per MIL-STD-883, Method 3015.4 /JESD22-A114-A (HBM). However, normal ESD precautions are still required during the handling of this module. This transceiver is shipped in ESD protective packaging. It should be removed from the packaging and handled only in an ESD protected environment.

## Laser Safety

This is a Class 1 Laser Product according to IEC 60825-1:2007. This product complies with 21 CFR 1040.10 and 1040.11 except for deviations pursuant to Laser Notice No. 50, dated (June 24, 2007).

## Pin Assignment and Description

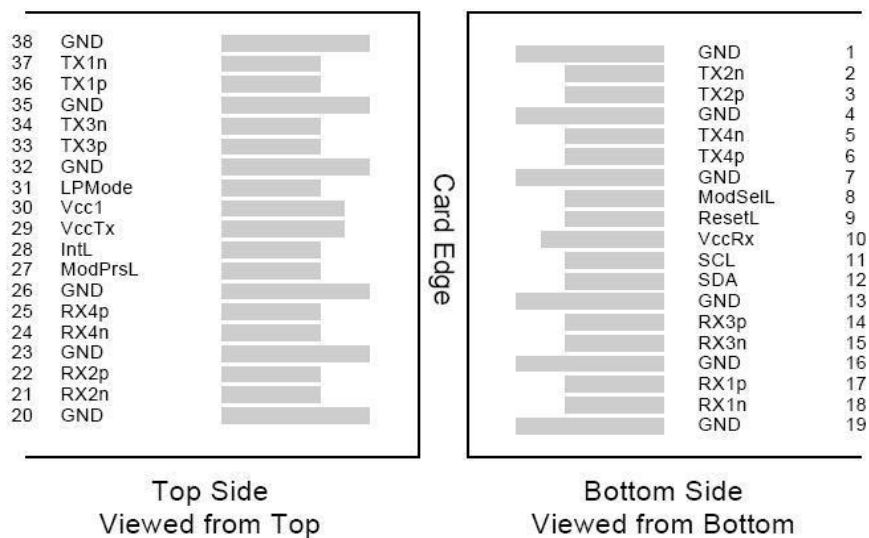

## Pin Assignment

| PIN # | Logic       | Symbol  | Description                          | Notes |
|-------|-------------|---------|--------------------------------------|-------|
| 1     |             | GND     | Ground                               | 1     |
| 2     | CML-I       | Tx2n    | Transmitter Inverted Data Input      |       |
| 3     | CML-I       | Tx2p    | Transmitter Non-Inverted Data output |       |
| 4     |             | GND     | Ground                               | 1     |
| 5     | CML-I       | Tx4n    | Transmitter Inverted Data Input      |       |
| 6     | CML-I       | Tx4p    | Transmitter Non-Inverted Data output |       |
| 7     |             | GND     | Ground                               | 1     |
| 8     | LVTLL-I     | ModSelL | Module Select                        |       |
| 9     | LVTLL-I     | ResetL  | Module Reset                         |       |
| 10    |             | VccRx   | +3.3V Power Supply Receiver          | 2     |
| 11    | LVC MOS-I/O | SCL     | 2-Wire Serial Interface Clock        |       |
| 12    | LVC MOS-I/O | SDA     | 2-Wire Serial Interface Data         |       |
| 13    |             | GND     | Ground                               |       |
| 14    | CML-O       | Rx3p    | Receiver Non-Inverted Data Output    |       |
| 15    | CML-O       | Rx3n    | Receiver Inverted Data Output        |       |
| 16    |             | GND     | Ground                               | 1     |

|    |         |         |                                     |   |
|----|---------|---------|-------------------------------------|---|
| 17 | CML-O   | Rx1p    | Receiver Non-Inverted Data Output   |   |
| 18 | CML-O   | Rx1n    | Receiver Inverted Data Output       |   |
| 19 |         | GND     | Ground                              | 1 |
| 20 |         | GND     | Ground                              | 1 |
| 21 | CML-O   | Rx2n    | Receiver Inverted Data Output       |   |
| 22 | CML-O   | Rx2p    | Receiver Non-Inverted Data Output   |   |
| 23 |         | GND     | Ground                              | 1 |
| 24 | CML-O   | Rx4n    | Receiver Inverted Data Output       | 1 |
| 25 | CML-O   | Rx4p    | Receiver Non-Inverted Data Output   |   |
| 26 |         | GND     | Ground                              | 1 |
| 27 | LVTTL-O | ModPrsL | Module Present                      |   |
| 28 | LVTTL-O | IntL    | Interrupt                           |   |
| 29 |         | VccTx   | +3.3 V Power Supply transmitter     | 2 |
| 30 |         | Vcc1    | +3.3 V Power Supply                 | 2 |
| 31 | LVTTL-I | LPMode  | Low Power Mode                      |   |
| 32 |         | GND     | Ground                              | 1 |
| 33 | CML-I   | Tx3p    | Transmitter Non-Inverted Data Input |   |
| 34 | CML-I   | Tx3n    | Transmitter Inverted Data Output    |   |
| 35 |         | GND     | Ground                              | 1 |
| 36 | CML-I   | Tx1p    | Transmitter Non-Inverted Data Input |   |
| 37 | CML-I   | Tx1n    | Transmitter Inverted Data Output    |   |
| 38 |         | GND     | Ground                              | 1 |

Notes:

1. GND is the symbol for signal and supply (power) common for QSFP+ modules. All are common within the QSFP+ module and all module voltages are referenced to this potential unless otherwise noted. Connect these directly to the host board signal common ground plane.

2. VccRx, Vcc1 and VccTx are the receiving and transmission power suppliers and shall be applied concurrently. Recommended host board power supply filtering is shown in Figure 3 below. Vcc Rx, Vcc1 and VccTx may be internally connected within the QSFP+ transceiver module in any combination. The connector pins are each rated for a maximum current of 500mA.

## Contact Information

### Wuhan RayOptekCO.,Ltd

Headquarter

📍 Address:G3-201, New Energy Building, No.999 Gao Xin Road, Wuhan, Hubei, China

☎ Tel:+86-27-87106345

✉ Email:sales@rayoptek.com